

PRECISION PENCIL TYPE MICRO AIR GRINDER

IMPULSE Series

IMPULSE SERIES ◀◀

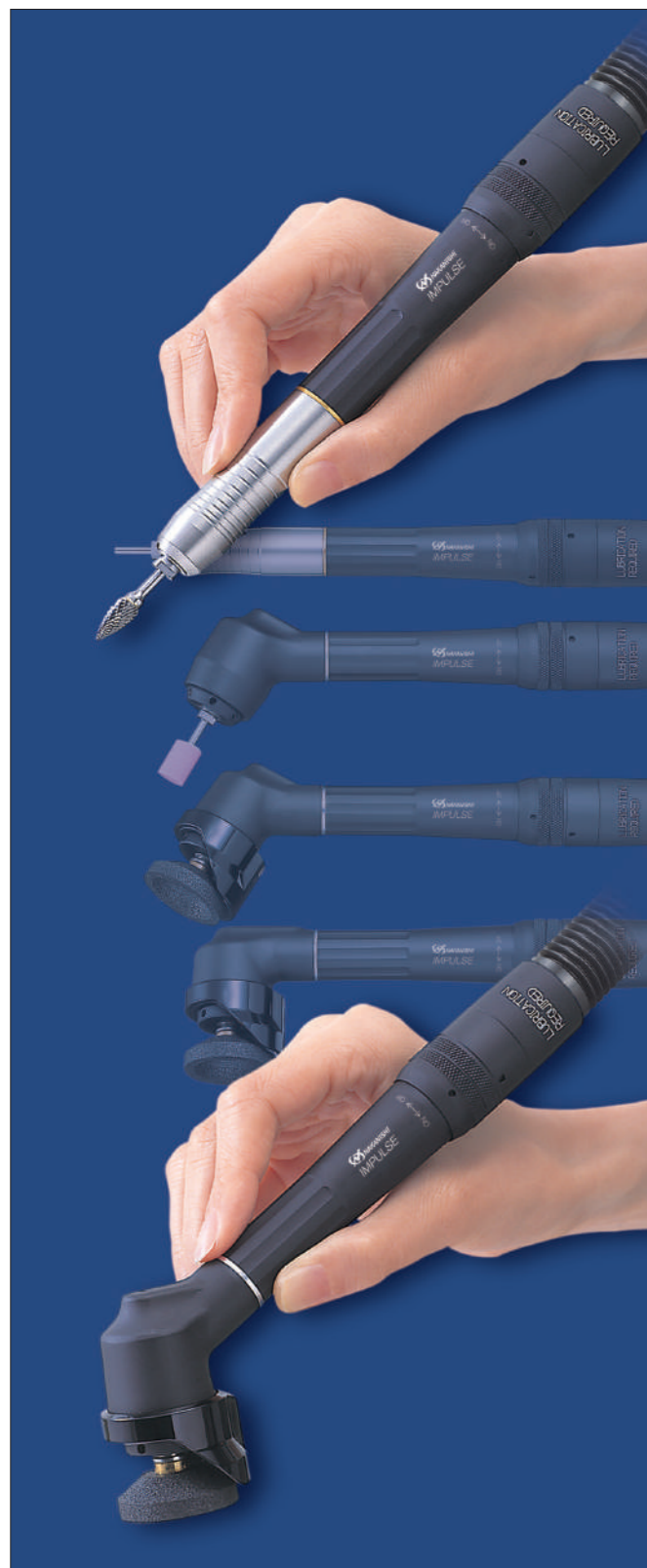
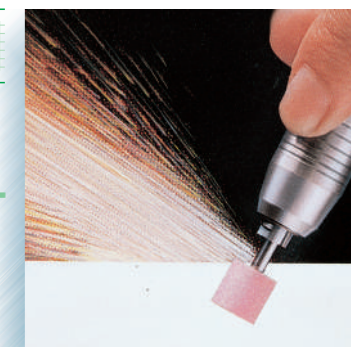

- ① 60,000 min⁻¹ NSP-601
- ② 40,000 min⁻¹ NA45-400 (60°)
- ③ 23,000 min⁻¹ NA45-230 (60°)
- ④ 23,000 min⁻¹ NA90-230 (90°)

- Precision and high accuracy
The smooth rotation without runout or vibration even at high speeds makes it ideal for precise microfabrication.
- High power and high torque
NAKANISHI air motors are equipped with a special vane motor. The rotation speed is maintained even under fluctuating grinding loads, ensuring stable grinding.
- Outstanding noise reduction
A silencer is attached to the end of exhaust hose as a standard.
- Excellent cost performance
The Impulse series offers excellent features at a very reasonable price.

Special Rotary Vane Air Motor

A special rotary vane air motor is used at the heart of the handpiece. The motor prevents the decrease in RPM that may occur due to processing load and maintains a stable grinding process.

Exchangeable Collet

Standard Size : $\phi 3.0$ mm (CHS-3.0)
Optional Collets : CHS Group $\phi 0.8$ ~ $\phi 3.175$ mm

Twist Free Hose

The grinder and dual hoses (air supply and exhaust) are not fixed, and the hoses swivel freely 360° without twisting. (IM-301)

60,000 min⁻¹



Straight IMPULSE		
Code No.	1034	Model NSP-601

ON / OFF Ring

Easy to switch ON / OFF and to adjust the motor speed, turning right & left.

Built-in Air Filter

Built in air filter in air inlet coupling (the connection to Air Line Kit).

Set-Up Drawing

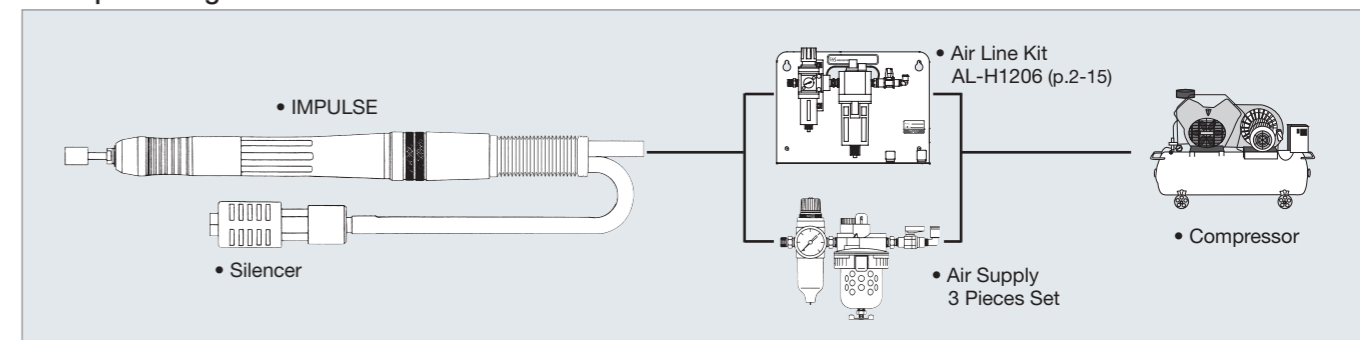

■ Use Air Line Kit AL-H1206 or air supply 3 pieces set. (Air Filter, Air Regulator, Lubricator)

CAUTION

Electric System

Air System

Ultrasonic

General Parts

Exclusive Tools

CAUTION

Electric System

Air System

Ultrasonic

General Parts

Exclusive Tools

IMPULSE AIR GRINDER ◀◀

PRECISION AIR GRINDER

Straight / 60° IMPULSE



Straight IMPULSE

60,000 min⁻¹

Code No.	1034
Model	NSP-601

Standard Size Collet

ø3.0 mm (CHS-3.0)

Optional Collets :
CHS Group are shown in page (p.4-4)



- Straight type is ideal for high speed precision grinding.
- The front part of the NSP-601 model is made of stainless steel ; the back portion of aluminum alloy.
- The safety design of clamping the chuck up to 29 mm maintains stable rotation of the cutting tool.
- The air motor is assembled with a special vane design which keeps constant speed under load providing stable grinding and polishing operation.

60° IMPULSE

40,000 min⁻¹

Code No.	1035
Model	NA45-400

Standard Size Collet

ø3.0 mm (CHS-3.0)

Optional Collets :
CHS Group are shown in page (p.4-4)



- Angle model's housing are made of aluminum alloy.
- Ideal for removing sharp edges at corners and surfaces difficult to reach with straight type handpieces.



Specifications

Air Consumption : 165 Nℓ /min
 Proper Air Pressure : 0.4~0.6 MPa
 Inlet Air Hose Length : 1.5 m
 Eraser Hose Length : 1.2 m

Standard Accessories

- Collet ø3.0 mm (CHS-3.0) : 1 pc.
- Mounted Point (42423) • Hose (K-213) : 1.5 m
- Silencer (K-208) : 1 pc. • Wrench (8 x 5) : 1 pc.
- Bar Wrench (K-212) : 1 pc.

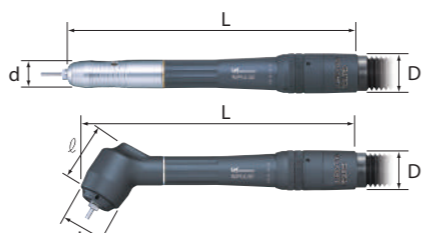

Code No.	d	D	ℓ	L	Weight	Speed	Collet
1034	ø17	ø23.9	—	168	165 g	60,000 min ⁻¹	ø0.8~ø3.175 mm
1035	ø28.6	ø23.9	39.6	161	210 g	40,000 min ⁻¹	CHS Group (p.4-4)

IMPULSE AIR GRINDER ◀◀

PRECISION AIR GRINDER

Super Cut IMPULSE



Exclusive Tools p.5-25~30

90° Super Cut IMPULSE

23,000 min⁻¹

Code No.	1036
Model	NA90-230

Standard Size Collet

ø3.0 mm (CHS-3.0)

Optional Collets :
CHS Group are shown in page (p.4-4)



Exclusive Tools p.5-25~30

Standard Accessories

Code No.	Description	Package
42423	Mounted Points	1 pc.
64822	Rubber Pad	1 pc./pack
64836	Cup Wheel	
64837	Cup Wheel	
64222	Sand Paper Disk ø31 #120	2 pcs./pack
64225	Sand Paper Disk ø31 #320	
64227	Sand Paper Disk ø31 #600	

▶ Disks → p.5-25~30



Please refer to next page.

60° Super Cut IMPULSE

23,000 min⁻¹

Code No.	1037
Model	NA45-230

Standard Size Collet

ø3.0 mm (CHS-3.0)

Optional Collets :
CHS Group are shown in page (p.4-4)



Exclusive Tools p.5-25~30

Standard Accessories

Code No.	Description	Package
42423	Mounted Points	1 pc.
64822	Rubber Pad	1 pc./pack
64836	Cup Wheel	
64837	Cup Wheel	
64222	Sand Paper Disk ø31 #120	2 pcs./pack
64225	Sand Paper Disk ø31 #320	
64227	Sand Paper Disk ø31 #600	

▶ Disks → p.5-25~30



Please refer to next page.



Specifications

Air Consumption : 165 Nℓ /min
 Proper Air Pressure : 0.4~0.6 MPa
 Inlet Air Hose Length : 1.5 m
 Eraser Hose Length : 1.2 m

Standard Accessories

- Grindstone Axis (NCH-01) : 1 pc.
- Silencer (K-208) : 1 pc. • Wrench (8 x 5) : 1 pc.
- Bar Wrench (K-212) : 2 pcs. • Hose (K-213) : 1.5 m
- Allen Wrench (1.5 mm) : 1 pc.

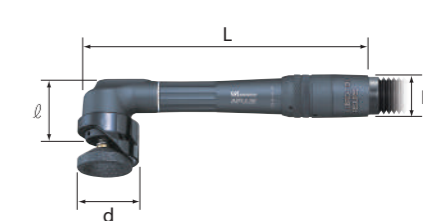

Code No.	d	D	ℓ	L	Weight	Speed	Collet
1036	ø33.5	ø23.9	34	156	190 g	23,000 min ⁻¹	ø0.8~ø3.175 mm
1037	ø33.5	ø23.9	39.6	163	190 g	23,000 min ⁻¹	CHS Group (p.4-4)

Air Line Kit (Automatic Lubricating Device)

Code No. **4506**

Model **AL-H1206**

- Standard Accessories**
- Air Pressure Gauge • Air Regulator
 - Air Filter • Lubricator
 - Air ON-OFF Valve
 - Piping Hose (K-275) : 2 m
 - Lubricating Oil (K-211) : 1 pc.



300(W) x 120(D) x 220(H) mm

- Supplies a smooth air flow and automatic lubrication for long life and stable power.
- By adjustment of auto lubrication and air flow, this will help extend the life of air grinder.
- Best for grinding and polishing processes, AL-H1206 Air Line Kit has a compact body with a carrying handle and holder to put the IMPULSE in.

◆ Weight : 2.2 kg ◆ Filter Mesh : 5 μm

Piping Connection Diagram

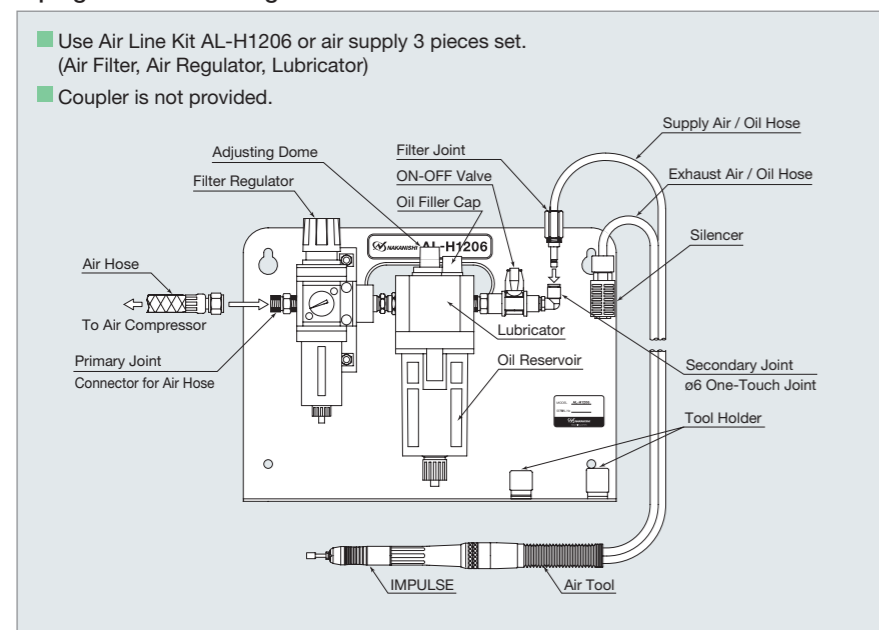

IMPULSE Series Spare Parts

Product	Description	Code No.	Model	Fit to
	Grindstone Arbor (for Cup Wheel & Rubber Pad)	1045	NCH-01	IMPULSE
	Head Cover	1043	CNA	IMPULSE
	Hose 1.5 m	1038	K-213	IMPULSE
	Silencer Small (w/Metal Fittings)	1061	K-208	IMPULSE
	Wrench 8 x 5	2012	—	IMPULSE
	Bar Wrench (72 mm)	2013	K-212	IMPULSE
	Allen Wrench (1.5 mm)	—	—	IMPULSE Available in the market
	Lubricating Oil (70cc)	1057	K-211	For Air Line Kit AL-H1206
	Lubricating Oil (1L)	1058	K-202	
	Filter Joint (for ø6 Quick Disconnecting Joint)	2039	FJ-02	(For K-213 Hose)

The Exchangeable Attachment Chart

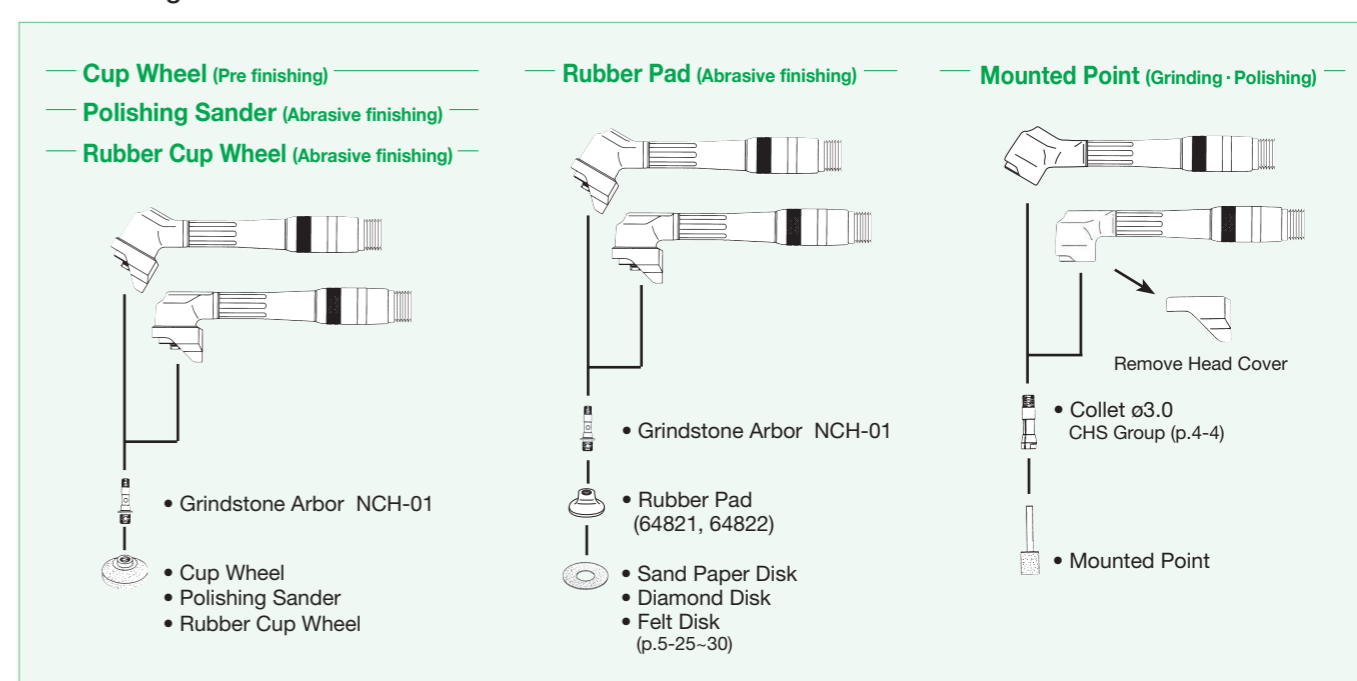

Rubber Pad

- Attach and use various types of polishing discs. (Refer to p.5-25~30)
- The elasticity of the rubber makes it ideal for finishing flat to curved surfaces.

5 per pack 23,000 min⁻¹ Max.

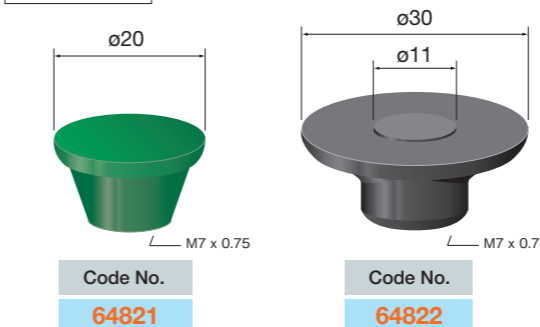

Cup Wheel

Standard type Wheel height ø20...6 mm ø30...5 mm
Overall height 10 mm

- A highly elastic grinding wheel with both grinding and polishing capabilities.
- It makes the most out of the high power of IMPULSE to machine flat and curved surfaces with high efficiency and softness.
- Compared with grinding wheels, there is no bite and the roughness of the finished surface can be finely adjusted.
- The use of a special bonding agent reduces clogging and allows the processing of a wide range of materials including general steel, aluminium, copper, brass and castings.

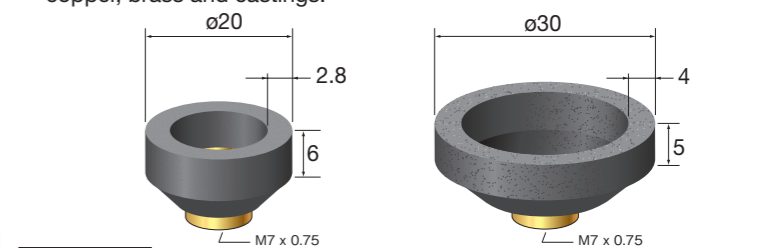

Flap Sanding Disc

- This is a sanding disc for high speed rotation with layered and bonded abrasive cloth.
- Compared to a grindstone, it has a softer bite for faster polishing.
- The overlapping abrasive cloths provide a new abrasive surface, resulting in excellent durability.

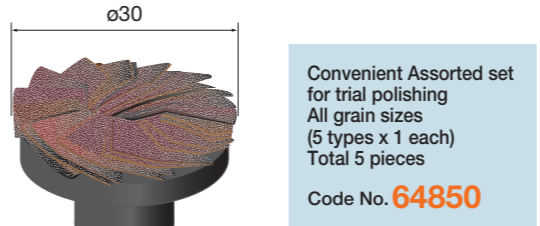

5 per pack 23,000 min⁻¹ Max.

Grit	Code No.
# 80	64842
# 120	64844
# 180	64846
# 240	64847
# 400	64849

12 per pack 23,000 min⁻¹ Max.

Grit	Wheel hardness	Code No. (ø20)	Code No. (ø30)
#36	Standard	64830	64835
#46	Hard	64831	64836
#80	Standard	64832	64837
#80	Hard	—	64838

Thin long-life type

Wheel height 7.5 mm Overall height 10 mm
Ideal for tight spaces and detail works.



10 per pack 23,000 min⁻¹ Max.

Grit	Wheel hardness	Code No.
#36	Hard	64861
#46	Hard	64862
#80	Hard	64863

Long-life type

Wheel height 12 mm Overall height 14.5 mm
20% longer Wheel life than Standard type.

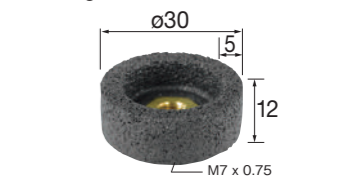

10 per pack 23,000 min⁻¹ Max.

Grit	Wheel hardness	Code No.
#36	Hard	64865
#46	Hard	64866
#80	Hard	64867

Rubber Cup Wheel

- Highly elastic rubber grinding wheel with both grinding and polishing properties.
- Highly efficient machining of flat and curved surfaces with a soft touch utilizing the high power of IMPULSE.
- Compared with grinding wheels, the impulse wheel does not bite and allows fine adjustment of roughness of finished surfaces.
- The use of a special bonding agent reduces clogging and enables machining of a wide range of materials, including general steel, aluminum, copper, brass, and castings.



NA90-230

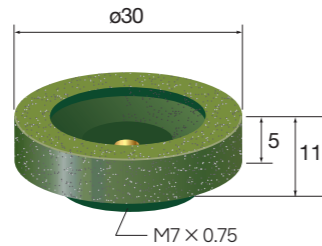

10 per pack 23,000 min⁻¹ Max.

Grit	Color	Code No.
# 60	Brown	64851
# 80	Red	64852
# 120	Blue	64853
# 180	Olive	64854
# 220	Green	64855
# 320	Brown	64856

Convenient Assorted set for trial polishing
All grain sizes (6 types x 2 each)
Total 12 pieces
Code No. **64859**

Welded Diamond Cup Wheel



Diamond abrasive grains are welded to the surface of the cup-shaped base under vacuum and high temperature conditions using a special alloy.

<6 Key Features> Cost saving and ecological benefits

- ① Significantly reduced dust generation and improved working environment. Generally, resinoid wheels generate a lot of dust due to their own wear and tear. This wheel does not generate any dust from itself.
- ② The large protrusion of diamond abrasive grains gives a sharp cutting edge and a much better cutting power.
- ③ The special welding method ensures strong diamond grain retention and excellent durability.
- ④ Greatly reduced sparks and odours during grinding.
- ⑤ No wear of the wheel itself and no change in the wheel's rim speed, resulting in a uniform surface.
- ⑥ Longer wheel life, less tool changes and less wasted machining time.

<Applications>

Suitable for grinding cast irons, castings, hard rubbers, FRP, stones, concretes and hard materials.

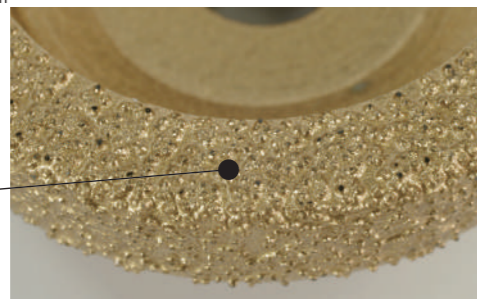
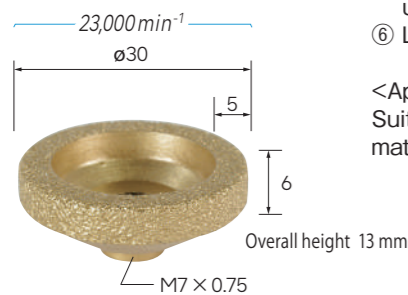

Enlarged photo of abrasive grains

1 per pack

Grit	Code No.
#60/#80	64871



PRESTO II AIR TURBINE GRINDER

ULTRA-HIGH SPEED AIR TURBINE GRINDER

PRESTO II

320,000 min⁻¹ ø1.6 mm Bur Only

- An astonishing 320,000 rpm. Smooth cutting without any resistance enables precise cutting and processing.
- Clean cutting is possible with the oilless air grinder. No oil sprays out to prevent the workpieces and hands from getting dirty.
- Lightweight aluminum body (71 g) with a palm-sized overall length (109 mm). High-precision processing of minute parts is possible at the same touch when holding a ball-point pen.

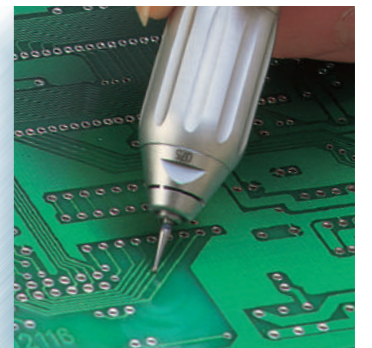

PRESTO II Standard Set

Code No. **1125**

Model **PRII-304S**

Standard Equipment

- Presto Handpiece (PR-304) : 1 pc.
- Air Line Kit (PRII-06) : 1 pc.
- Foot Controller (AFC-40) : 1 pc.
- Handpiece Holder (Z014) : 1 pc.



Specifications

Rotating Speed	: 320,000 min ⁻¹
Proper Air Pressure	: 0.25 MPa
Air Consumption	: 40 Nℓ/min
Inside Diameter	: ø1.6 mm Bur Only
Filter Mesh	: 5 μm

PRESTO Handpiece

320,000 min⁻¹

Code No. **1122**

Model **PR-304**

◆ Weight : 71 g (w/o Hose)

Standard Accessories

- 2 m Hose

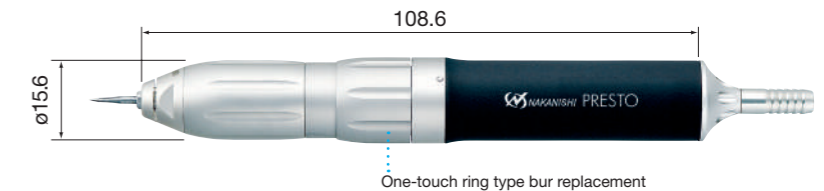

- Ultra-high speed no lube air turbine handpiece ideal for delicate processing application.
- Built-in dust protection mechanism developed by NAKANISHI ensures long durability.
- Chip air blows away the cutting powder and cools the cutting tool.
- Flexible tubing ensures excellent workability reducing fatigue to the operator's hand for long continuous use.

PRESTO II Spare Parts

Product	Description / Specifications	Code No.	Model
	PRESTO II Air Line Kit (w/o Lubricator / Filter Mesh 5 μm)	1126	PRII-06
	PRESTO II Cartridge	1120	PR-03
	Foot Controller	1124	AFC-40
	Piping Hose (ø6.0) 2 m Long	2041	K-237
	Air Turbine Hose (ø5.1) 2 m Long	2042	K-238
	Pin Wrench	2002	T-751

ø1.6 mm tools for PRESTO II



For safe usage

- Please read operation manuals before using any NAKANISHI product.
- Please keep the operation manuals on hand so that the user can refer to them at any time.

⚠ Caution

Incorrect use of the product, or ignoring 'CAUTIONS for safety' described in the operating manuals may cause fatal or serious bodily injury.

CAUTIONS

	Always use safety glasses, masks, face guards for your safety.		Select proper hand tools and for your application. Select tools carefully considering the performance of the hand tools, work procedure and type / shape of the material.
	Do not touch the tools and hand tools when in operation. Make sure the work area is neat and there is sufficient light.		Do not wear loose clothing and/or accessories that may be caught in machinery. Long hair should be tied prior to machine operation.
	Do not operate the products where flammable liquids or gases exist.		Fix the work material firmly in a vise and/or other clamping fixture.
	Do not leave the work area with the hand tools still in operation. Confirm that the hand tools have completely stopped after switching them off.		Perform an inspection before use. Clean the inside of the collet and tool shank, chips or fine metals inside the collet could cause tool slippage and result in damage to machinery or bodily injury.

	Fasten the chuck firmly. Make sure the tool is intact in the chuck to avoid tool slippage.		Do not apply high pressure or pry to the tools. This can break and/or bend the tools. Use the tools within their design limitation. Excessive pressure will decrease the efficiency of your work and cause excessive wear of the tools.										
	Do not use damaged or broken electric cords and air hoses.		Check the tools carefully before use. Confirm that the tools are free of chips, cracks, splits, scratches, lack of bonding, deformation, etc.										
	Start at low speed and gradually increase to insure safe work. This is particularly important for the use of new tools, large cutting tools and elastic tools such as rubber grindstone, sander and brush tools.		Stop grinding or polishing immediately whenever unusual sounds, vibrations, or wear are found. Restart the work only after the problem is solved.										
	Store the tools and hand tools in a cool and dry place.		Only use attachments, parts, consumable articles and accessories produced by NAKANISHI INC.										
	The tools should be used by taking care of the overhang and below maximum allowable speed. The catalogue shows the maximum allowable speed at 10 mm overhang (distance between the face of the collet and the top of the tool shank).	<p>Decrease the speed as shown in the table below, if you are using a longer overhang than 10 mm.</p> <table border="1"> <thead> <tr> <th>Overhang</th> <th>Maximum allowable speed (min⁻¹)</th> </tr> </thead> <tbody> <tr> <td>Less than 10 mm</td> <td>Shown in the catalogue (A)</td> </tr> <tr> <td>Less than 20 mm</td> <td>(A) x 0.5</td> </tr> <tr> <td>Less than 25 mm</td> <td>(A) x 0.3</td> </tr> <tr> <td>Less than 50 mm</td> <td>(A) x 0.1</td> </tr> </tbody> </table>		Overhang	Maximum allowable speed (min ⁻¹)	Less than 10 mm	Shown in the catalogue (A)	Less than 20 mm	(A) x 0.5	Less than 25 mm	(A) x 0.3	Less than 50 mm	(A) x 0.1
Overhang	Maximum allowable speed (min ⁻¹)												
Less than 10 mm	Shown in the catalogue (A)												
Less than 20 mm	(A) x 0.5												
Less than 25 mm	(A) x 0.3												
Less than 50 mm	(A) x 0.1												

The pages are organized by code number, so you can find the code number you need by checking the code numbers printed at the top of the left and right pages.

SHANK DIAMETER

SHANK $\phi 3.0$

Indicates the shank diameter of various types of shafted tools.

※ NAKANISHI micro grinders use a collet system to maintain high precision. Please prepare a collet that corresponds to each shank diameter.

Grit Size (Mesh Size)

#180

This indicates the size (roughness) of the abrasive grains used in various types of polishing / grinding materials. The larger the number, the smaller (finer) the grit size, and conversely, the smaller the number, the larger (coarser) the grit size (roughness). This is the most significant factor that affects the roughness of the finished surface.

- Rough Finishing ···· 46, 54, 60, 70, 80, 90
- Pre Finishing ······ 100, 120, 150, 180
- Middle Finishing ···· 220, 240, 280, 320, 400
- Finishing ········ 500, 600, 700, 800, 1000
- Extra Fine to Mirror Finishes ······ 1200, 1500, 1800, 2000, 3000, 4000, 6000, 8000···

Maximum Allowable Speed

30,000 min⁻¹

Do not exceed the maximum allowable speed. For safety reasons, always use below the indicated allowable speed.

If this is the first time you are using the equipment or tip tool, start with a low speed and gradually increase it to reach the most appropriate speed for use.

Conditions may vary depending on the type, shape, overall length, and wear condition of the tip tool, so please work with constant care.

※ The maximum allowable operating speed is for when the overhang is under 10 mm. If the overhang is more than 10 mm, please reduce the speed.

For details, please refer to "Precautions for use" on page A-3~4.

※ Make sure there are no mechanical defects in the equipment prior to each use.

Actual size illustration (excluding some tools and overall length)

Shank diameter of the tools listed on the facing page

The beginning of the Code Numbers listed on the facing page. (The last number listed is found on the right side.)

Quantity in Standard Package

1 pc./pack

A standard package is the minimum shipping unit. This number shows the number of pieces in the standard package (bag, box, etc.). Please order the number of packages needed for the desired quantity.

11131~

**Angle Type Grinder
(Electric / Pneumatic)**
Exclusive Tools for "MINI ANGLE Type"

NAKANISHI Angle Grinders are available with a wide range of tools for a variety of machining operations, from cutting to grinding, polishing and lapping.

SHANK DIAMETER

SHANK $\phi 1.6$

MINI Angle Type

Diamond Burs for Deep Hole Chamfering

SHANK $\phi 1.6$ 1 pc./pack

Diamond Burs for Deep Hole Chamfering

- Ideal for machining hardened steel, cemented carbide, ceramics, etc.

320,000 min⁻¹

#130

$\Delta 30^\circ$

$\phi 2.5$

$\phi 1.6$ 19

11131

$\phi 3$

$\phi 1.6$ 20

11132

$\phi 4$

$\phi 1.6$ 21

11133

320,000 min⁻¹

#140

$\Delta 60^\circ$ $\Delta 90^\circ$ $\Delta 110^\circ$

$\phi 3$

$\phi 1.6$ 20

11151

$\phi 5$

$\phi 1.6$ 20

11152

$\phi 3$

$\phi 1.6$ 20

11153

$\phi 5$

$\phi 1.6$ 20

11154

$\phi 3$

$\phi 1.6$ 20

11155

$\phi 5$

$\phi 1.6$ 20

11156

Tools of $\phi 1.6$ mm shank

Diamond Burs

Carbide Burs

Mounted Abrasive Points

Abrasive Rubber Points

P.5-31

Maximum Allowable Speed
Grit Size

Quantity in Standard Package

Overall length

Code No. (Order Number)

Photograph of the basic shape

Note : Specifications may change without notice. The color of the tools in the catalog may differ from the actual color due to printing and other factors.

64101~

Angle Type Grinder (Electric / Pneumatic) Exclusive Tools for "Angle Type"

~64274

SHANK DIAMETER

NAKANISHI Angle Grinders are available with a wide range of tools for a variety of machining operations, from cutting to grinding, polishing and lapping.

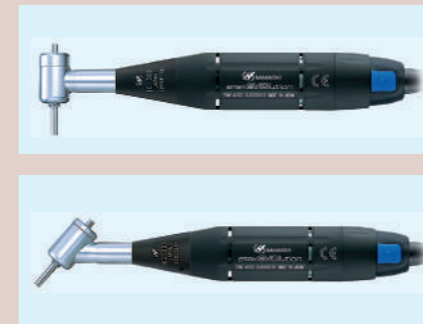
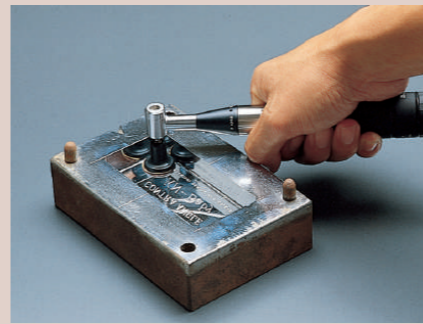

Angle Type



Special Rubber Pads for Abrasive and Felt Discs

- It is used by attaching various types of polishing discs.
- The elasticity of the rubber makes it ideal for finishing flat and curved surfaces.

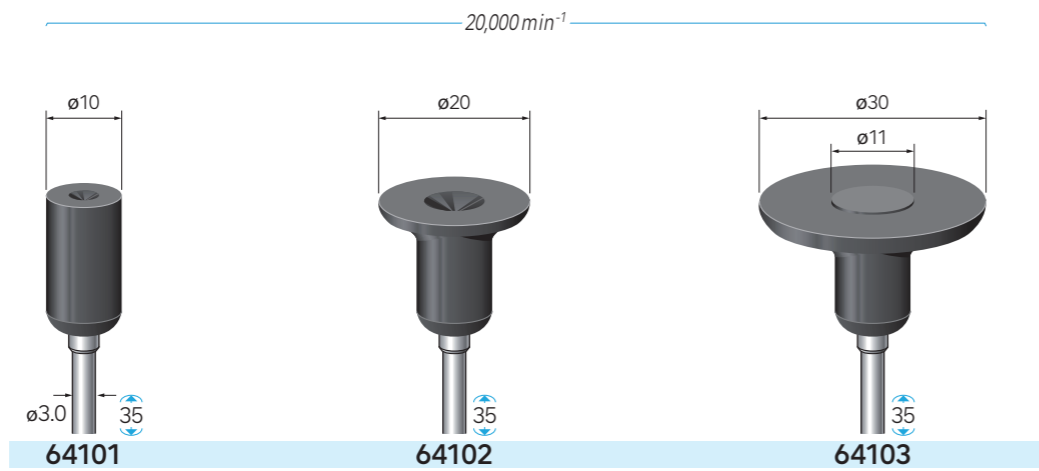

Sandpaper Discs (paper base type)

- Suitable for metal, woodwork, painted surfaces and putty polishing
- Use in dry conditions



		Adhesive Back		
Grit Size		ø11	ø21	ø31
# 80	64201	64211	64221	
# 120	64202	64212	64222	
# 180	64203	64213	64223	
# 240	64204	64214	64224	
# 320	64205	64215	64225	
# 400	64206	64216	64226	
# 600	64207	64217	64227	



Sandpaper Discs (fabric base type)

- Ideal for metalworking
- Excellent durability
- Use in dry conditions

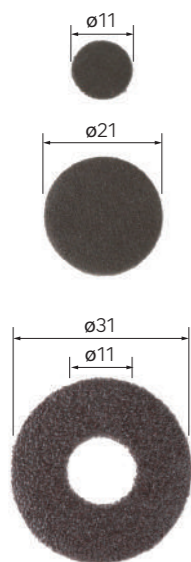

		Adhesive Back		
Grit Size		ø11	ø21	ø31
# 60	64111	64121	64141	
# 80	64112	64122	64142	
# 120	64113	64123	64143	
# 180	64114	64124	64144	
# 240	64115	64125	64145	
# 320	64116	64126	64146	
# 400	64117	64127	64147	
# 600	64118	64128	64148	



Zirconia Disks

- These discs are specially coated with zirconia abrasive grains to provide excellent cutting performance and durability for difficult-to-machine materials.
- Ideal for machining metals such as aluminium, stainless steel, copper alloys and brass, which are prone to clogging.



		Adhesive Back		
Grit Size		ø11	ø21	ø31
# 60	64251	64261	64271	
# 80	64252	64262	64272	
# 120	64253	64263	64273	
# 150	64254	64264	64274	

64331 ~

Angle Type Grinder (Electric / Pneumatic) Exclusive Tools for "Angle Type"

SHANK DIAMETER

NAKANISHI Angle Grinders are available with a wide range of tools for a variety of machining operations, from cutting to grinding, polishing and lapping.



~64432

Angle Type

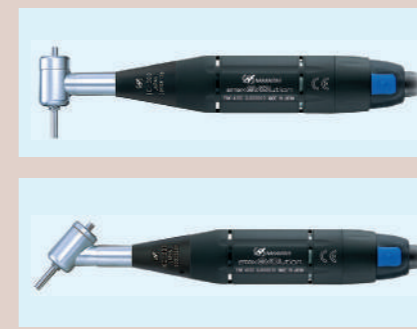

20 pcs./pack

Felt Discs

- Ideal for use in combination with various abrasives (diamond compound, polishing compound) for finish polishing.
- Made from 100% high quality sheep's wool, with moderate elasticity and sufficient durability for repeated polishing operations.
- High wool density ensures that abrasives and abrasive grains are held in place and the surface is polished.

Adhesive Back

Product name	ø11	ø21	ø31
Felt Discs (1 mm thick) Soft	64331	64332	64333
Felt Discs (2 mm thick) Soft	64335	64336	64337

* Sheeted types are available.

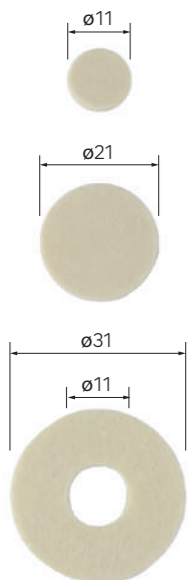

SHANK Ø3.0 5 pcs./pack

Rubber grinding wheel disc with shaft (Integrated rubber pad)

- The newly developed special rubber holds the abrasive grains with the right amount of hardness and boasts exceptional polishing ability.
- The grinding wheel part is integrally moulded into the rubber pad for superior workability.
- Highly efficient finishing of flat and curved surfaces with a soft touch.

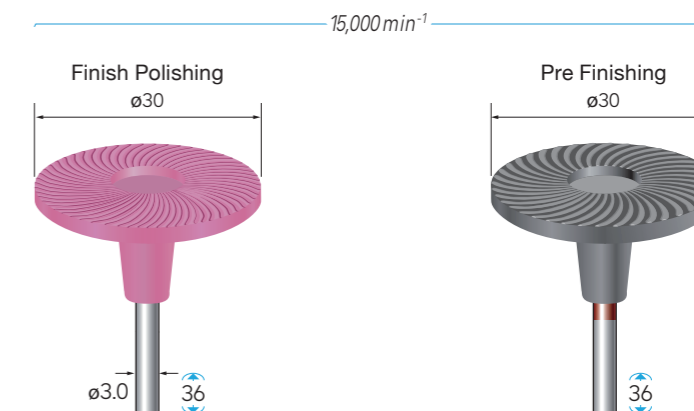
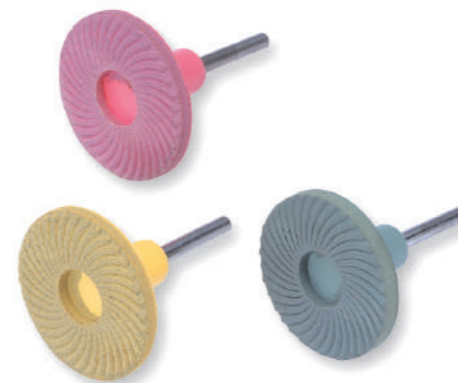

Finish Polishing

Grit Size	Color	WA abrasive grains	GC abrasive grains
# 80	Pink	64411	—
# 80	Purple	—	64421
# 120	Blue	64412	64422
# 180	Yellow	64413	—
# 180	Green	—	64423
# 220	Green	64414	64424
# 320	Purple	64415	64425
# 500	Orange	64416	—
# 500	Brown	—	64426

Pre Finishing (Excellent grindability)

Grit Size	Color	WA abrasive grains
# 80	Black(Red line)	64431
# 120	Black(Blue line)	64432

Angle Type Grinder (Electric / Pneumatic) Exclusive Tools for "Angle Type"

NAKANISHI Angle Grinders are available with a wide range of tools for a variety of machining operations, from cutting to grinding, polishing and lapping.

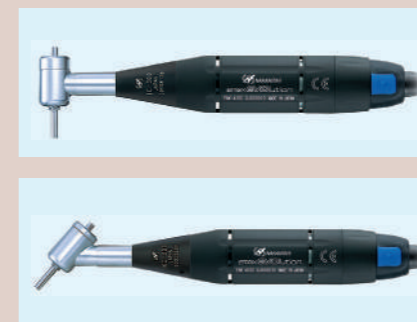
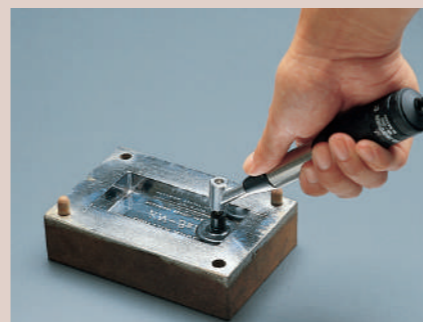

Angle Type

1 pc./pack

Diamond Discs (Full electroplated surface)

The base material is an ultra-thin copper alloy, with diamond abrasive grains electroplated over the entire surface.

- The metal base material has good electrodeposition plating conditions and adheres diamond abrasive grains uniformly and most firmly.
- Very good sharpness and durability.

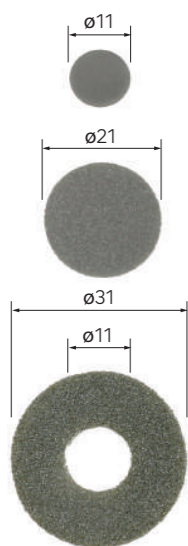

Adhesive Back

Grit Size	ø11	ø21	ø31
# 100	64451	64461	64471
# 140	64452	64462	64472
# 200	64453	64463	64473
# 280	64454	64464	64474
# 400	64455	64465	64475
# 600	64456	64466	64476
# 800	64457	64467	64477
# 1000	64458	64468	64478

* Sheeted types are available.

3 pcs./pack

Resin Bond Diamond Discs

Diamond abrasive grains are mixed with resin bond and coated on the resin base material.

- The resin component provides a uniform and stable finished surface and a soft grinding feel.
- ※ This resin bond type requires dressing only for the first use.
The cutting edges of the abrasive grains are exposed by lightly shaving the surface with a grindstone or diamond file.



Adhesive Back

Grit Size	ø11	ø21	ø31
# 80	64531	64541	64551
# 120	64532	64542	64552
# 180	64533	64543	64553
# 240	64534	64544	64554
# 400	64535	64545	64555
# 800	64537	64547	64557
# 1000	64538	64548	64558
# 2000	64539	64549	64559

1 pc./pack

Diamond Discs (Dot electroplated type for wet applications)

Nickel alloy pellets with diamond electrodeposition are strongly bonded to the Resin base material.

- The dot pattern is characterized by its strong grinding performance.
- Dot spaces allow chips and grinding fluid to flow smoothly.
- The resin base material is made of a fiber-filled resin that excels in flexibility and toughness.

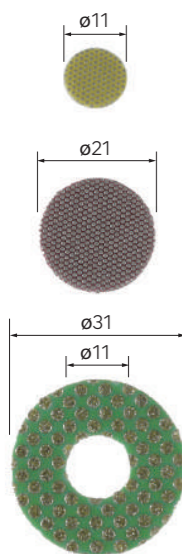

Adhesive Back

Grit Size	Color	ø11	ø21	ø31
# 60	Green	64501	64511	64521
# 120	Black	64502	64512	64522
# 200	Red	64503	64513	64523
# 400	Yellow	64504	64514	64524
# 800	Gray	64505	64515	64525

* Sheeted types are available.